

## K PUSH TECH

**K PUSH TECH** is the fully renewed and extended program of automatic opening systems for doors without handles or knobs.

A special inner mechanism provides a very silent, yet powerful utilization, granting a long durability which makes it perfectly suitable for a wide range of doors.

**K PUSH TECH** is available:

- with buffer, for cabinets using sprung hinges.
- with magnet, for cabinets using unsprung hinges or negative hinges (Highest magnet strength available in the market).

**K PUSH TECH** program, includes an innovated range of spring strengths and three lengths of the output paths:

Short – 14 mm, Medium – 20 mm, Long – 37 mm.

Gap between door and cabinet is reduced: activation gap is 1,4 mm, ring thickness is 0,6 mm.

Wide adjustment feature: +6 / -0.45 mm; beyond this negative adjustment the spring is deactivated.



PATENT PENDING  
REGISTERED DESIGN  
ISO 7170/05



### INSTALLATION TO BE EMBEDDED INSIDE THE PANEL

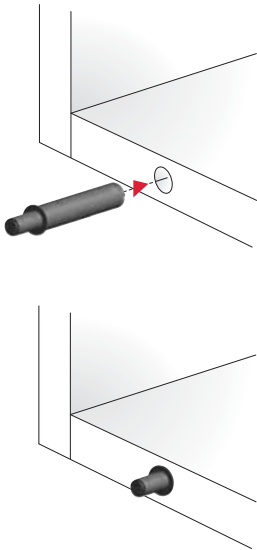

WITH MAGNET  
for cabinets using **unsprung hinges**  
or **negative hinges**.

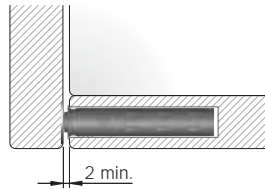

For details refer to  
"K PUSH TECH AND  
K LOCK DOOR PLATES".

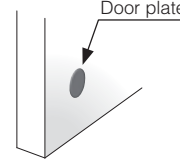

WITH BUFFER  
for cabinets using **sprung hinges**.

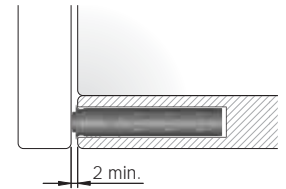

### VERSIONS

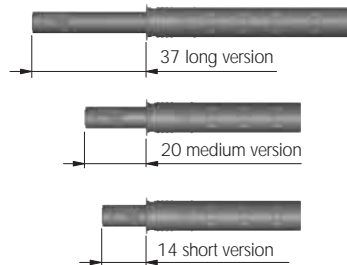

### ADJUSTMENTS

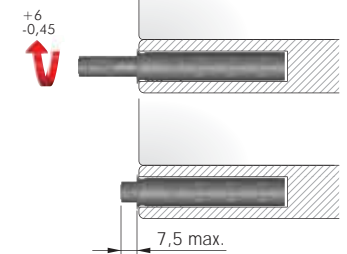

### INSTALLATION THROUGH ADAPTER HOUSING

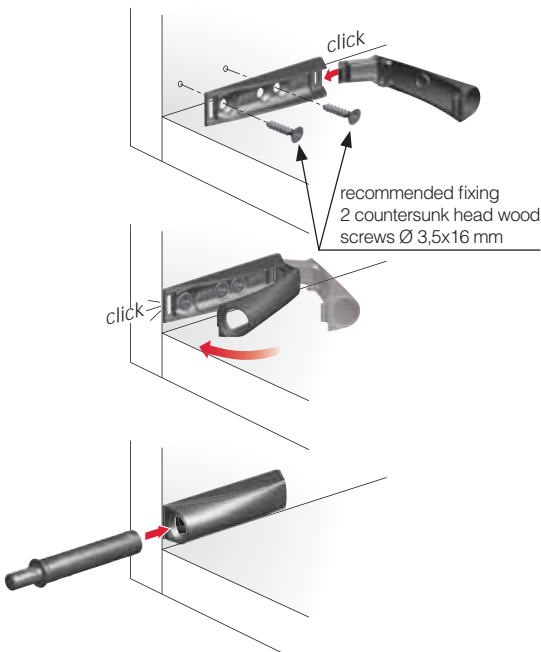

WITH MAGNET  
for cabinets using **unsprung hinges**  
or **negative hinges**.

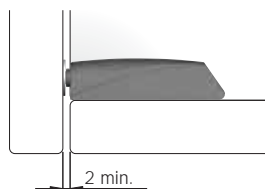

For details refer to  
"K PUSH TECH AND  
K LOCK DOOR PLATES".

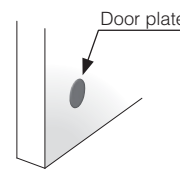

WITH BUFFER  
for cabinets using **sprung hinges**.

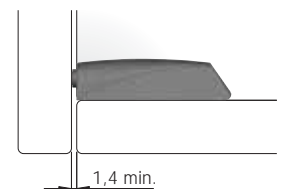

### VERSIONS

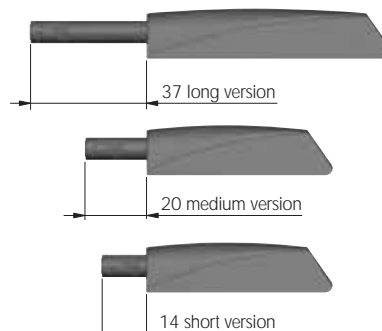

### ADJUSTMENTS

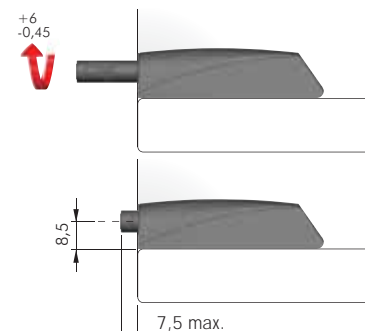



**APPLICATION WITH SPRUNG HINGES**

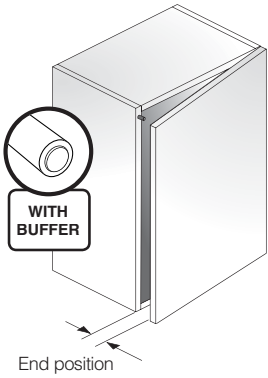

	14	20	37
<b>Adjacent doors</b>			
<b>Single door</b>			

**APPLICATION WITH UNSPRUNG HINGES**

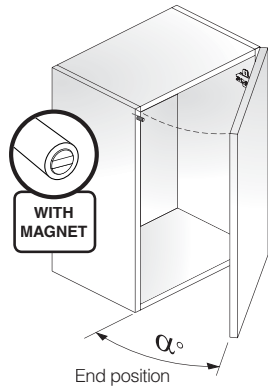
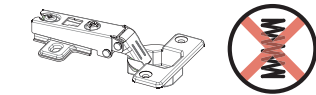

Door dimensions	Range weight	Indicative $\alpha^\circ$ end door position				
		14	20	20 (STRONG)	37	37 (STRONG)
Small door size	2 - 5 kg	$\pm 30^\circ$	$\pm 37^\circ$	$\pm 40^\circ$	$\pm 55^\circ$	$\pm 70^\circ$
Medium door size	5 - 8 kg	$\pm 25^\circ$	$\pm 30^\circ$	$\pm 35^\circ$	$\pm 45^\circ$	$\pm 50^\circ$
Large door size	15 - 18 kg	$\pm 20^\circ$	$\pm 28^\circ$	$\pm 30^\circ$	$\pm 40^\circ$	$\pm 45^\circ$
Maxi door size	30 - 35 kg	-	$\pm 20^\circ$	$\pm 25^\circ$	$\pm 30^\circ$	$\pm 35^\circ$

Small and Medium door size tested with 2 hinges. Large and Maxi size doors tested with 5 hinges. Please note that test results are indicative. End door position may vary depending on hinge brand.

**APPLICATION WITH NEGATIVE HINGES**

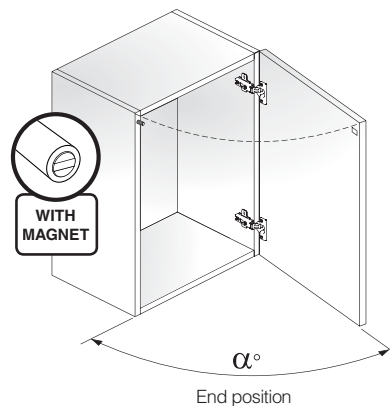
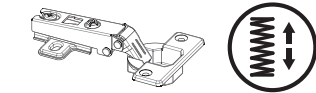

Door dimensions	Range weight	Indicative $\alpha^\circ$ end door position				
		14	20	20 (STRONG)	37	37 (STRONG)
Small door size	2 - 5 kg	$\pm 85^\circ$	$\pm 90^\circ$	$\pm 95^\circ$	Over $95^\circ$	Over $95^\circ$
Medium door size	5 - 8 kg	$\pm 70^\circ$	$\pm 85^\circ$	$\pm 90^\circ$	Over $95^\circ$	Over $95^\circ$
Large door size	15 - 18 kg	$\pm 40^\circ$	$\pm 50^\circ$	$\pm 60^\circ$	$\pm 70^\circ$	$\pm 80^\circ$
Maxi door size	30 - 35 kg	-	$\pm 35^\circ$	$\pm 40^\circ$	$\pm 50^\circ$	$\pm 60^\circ$

Small and Medium door size tested with 2 hinges. Large and Maxi size doors tested with 5 hinges. Please note that test results are indicative. End door position may vary depending on hinge brand.

## DROP DOWN DOORS

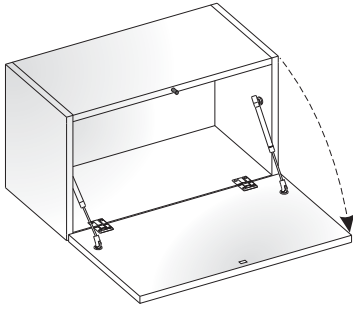

Please note that all technical specifications are based on cabinets assembled only with Italiana Ferramenta products.

### APPLICATION WITH: KIMANA HINGES

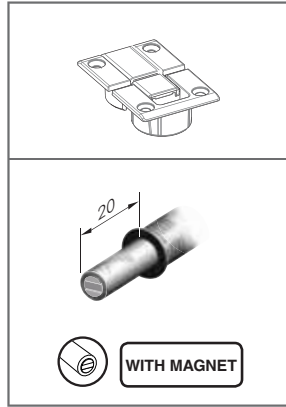

### APPLICATION WITH: UNSPRUNG HINGES

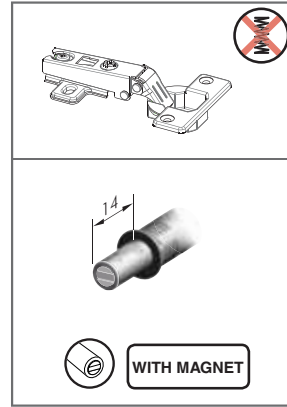

### APPLICATION WITH: SPRUNG HINGES

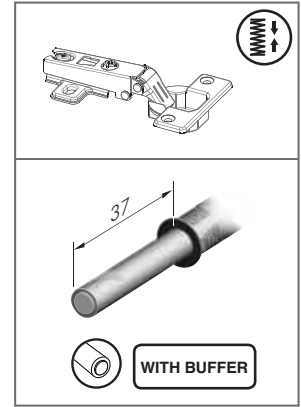

## LIFT UP DOORS

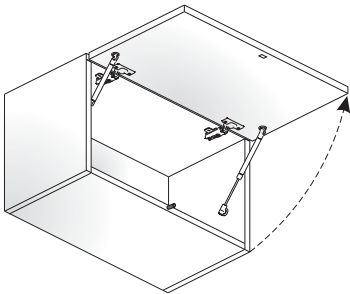

Please note that all technical specifications are based on cabinets assembled only with Italiana Ferramenta products.

### APPLICATION WITH: UNSPRUNG HINGES

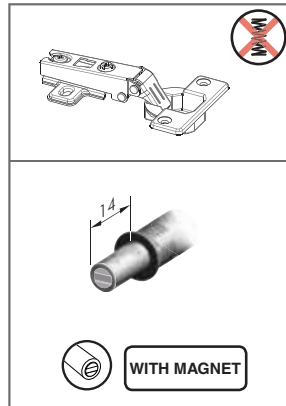

## SUGGESTED INSTALLING SPOTS FOR K PUSH TECH

● = K PUSH TECH suggested spot

● = Activating area of K PUSH TECH

### BASE CABINETS AND UPPER CABINETS WITH HINGED DOORS

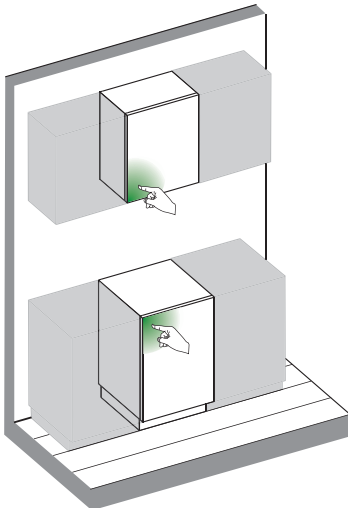
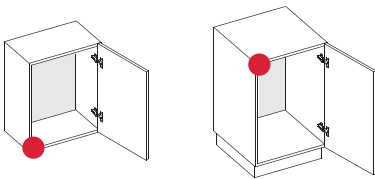

### TALL CABINETS WITH HINGED DOORS

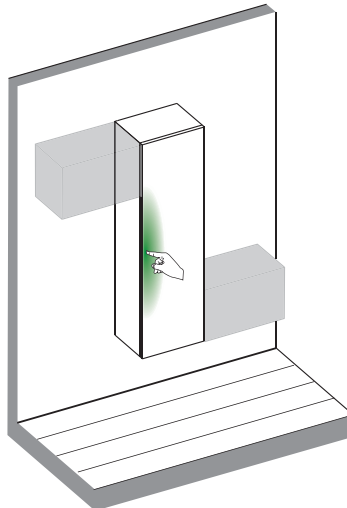
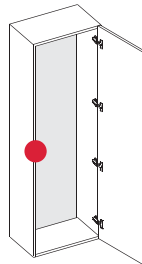

### BASE CABINETS AND UPPER CABINETS WITH FLAP DOORS

